

ANGLE SUPPORT

MAT'L: ALUM'Z, GALV., STAINLESS STEEL or ALUMINUM

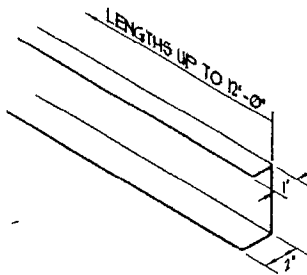

J-BAR SUPPORT

MAT'L: ALUM'Z, GALV., STAINLESS STEEL or ALUMINUM

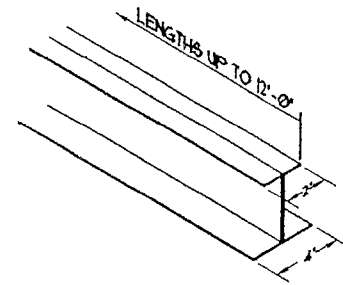

H-BAR SUPPORT

MAT'L: ALUM'Z, GALV., STAINLESS STEEL or ALUMINUM

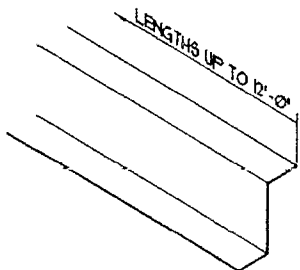

Z-BAR SUPPORT

MAT'L: ALUM'Z, GALV., STAINLESS STEEL or ALUMINUM

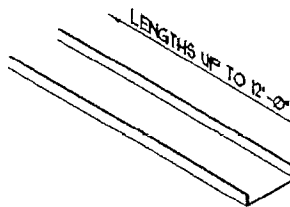

CHANNEL SUPPORT

MAT'L: ALUM'Z, GALV., STAINLESS STEEL or ALUMINUM

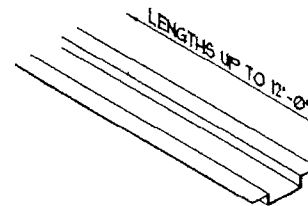

HAT CHANNEL SUPPORT

MAT'L: ALUM'Z, GALV., STAINLESS STEEL or ALUMINUM

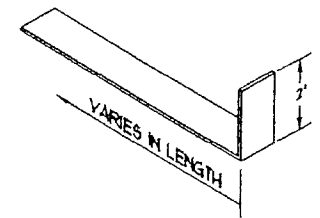

1/2" WIDE L-CLIP SUPPORT

MAT'L: ALUM'Z, GALV., STAINLESS STEEL or ALUMINUM

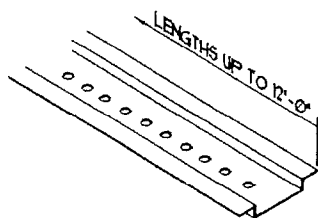

FOSTER WHEELER HAT SUPPORT

MAT'L: ALUM'Z, GALV., STAINLESS STEEL or ALUMINUM

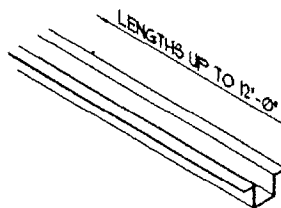

OMEGA BAR SUPPORT

MAT'L: ALUM'Z, GALV., STAINLESS STEEL or ALUMINUM

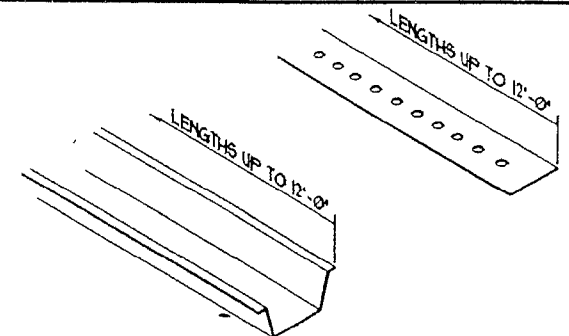

RILEY STOKER SUPPORTS

MAT'L: ALUM'Z, GALV., STAINLESS STEEL or ALUMINUM

THIS DRAWING IS PROPRIETARY TO ALLSTATE INSULATION WITH PERMISSION FROM VMS AND IS GRANTED UPON CONDITION THAT IT IS NOT TO BE COPIED IN WHOLE OR IN PART, OR USED FOR SUPPLYING INFORMATION TO OUTSIDE PARTIES AND WILL BE RETURNED UPON REQUEST.

FOR PRICING AND AVAILABILITY CONTACT ALLSTATE INSULATION
888-881-4822
E MAIL 888-881-4822

FOR:		DRAWN BY:	
SCALE: N.T.S.		DATE: 4/6/99	
MISC. SUPPORT STEEL			
DWG. NO.:		99 - VMT	